

ultracompact

sandwich

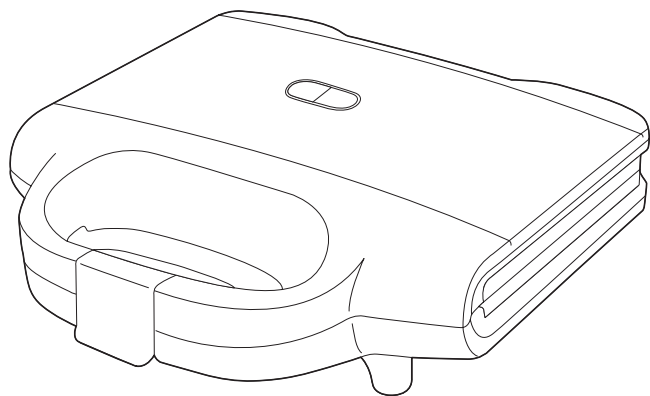

FR
NL
DE
IT
ES
PT
EN
EL
TR
DA
NO
SV
FI
PL
RU
UK
CS
SK
HU
SL
SR
BS
HR
RO
BG
ET
LT
LV
AR
FA
KK
VI
ZH

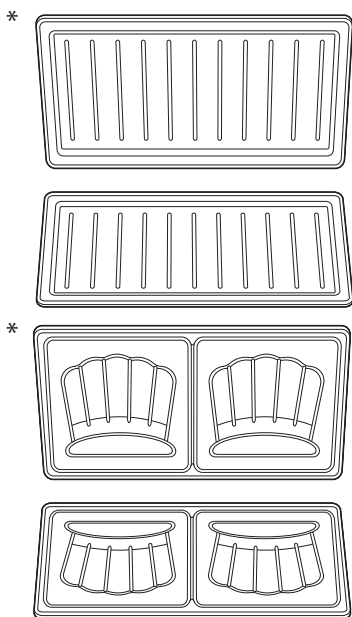
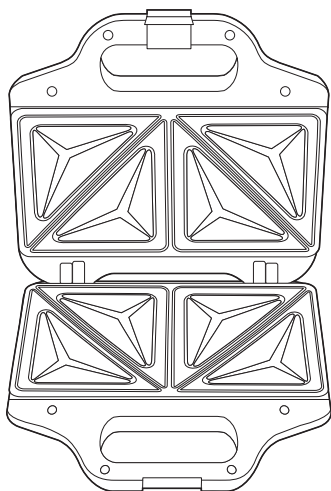
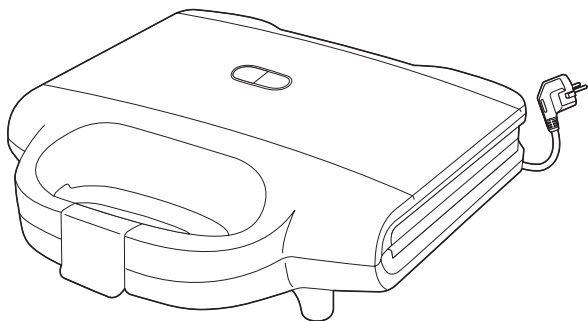

*selon modèle - afhankelijk van het model - je nach Modell - secondo il modello - según modelo - consoante o modelo - depending on the model - Ανάλογα με το μοντέλο - modele göre - afhængig af modellen - avhengig av modell - beroende på modell - mallista riippuen - w zależności od modelu - в зависимости от модели - залежно від моделі - podle modelu - podľa modelu - modelitól függően - glede na model - u zavisnosti od modela - zavisno od modela - ovisno o modelu - în funcție de model - в зависимости от модели - söltuvalt modelist - priklausomai nuo modelio - Atkaribà no modelja - بر حسب مدل - حسب الموديل - үлгісіне қарай - Туу

1

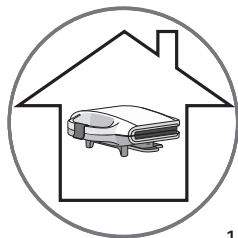

1



2

2

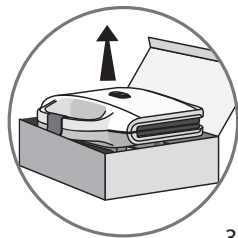
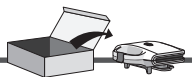

3



4



5

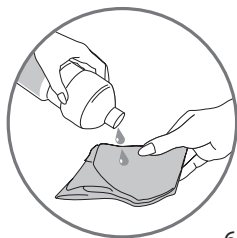

6



7



8

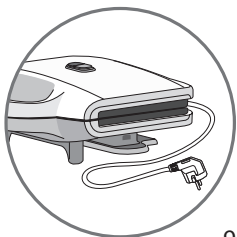

9

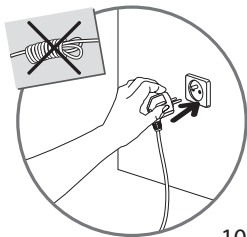

10

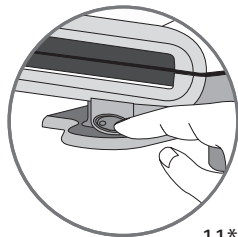

11*

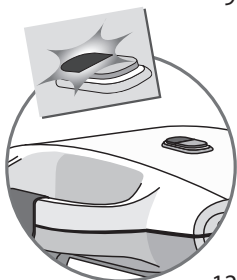

12



13

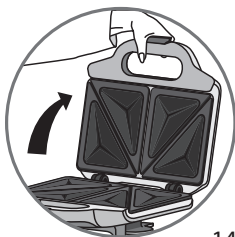

14



15



16

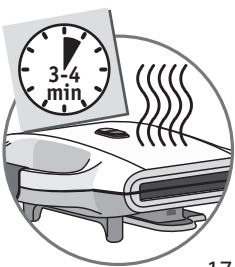

17

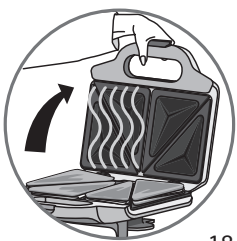

18



19

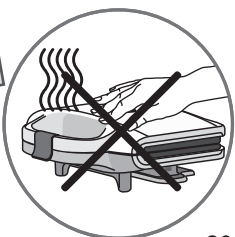

20

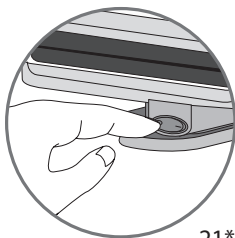

21*

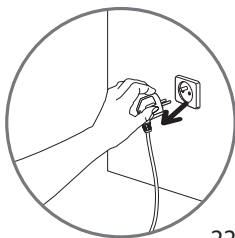

22

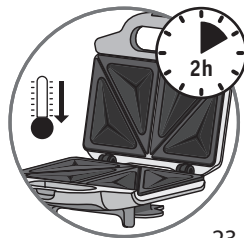

23



24

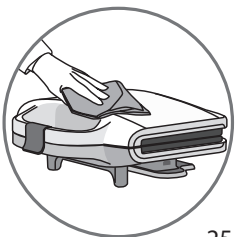

25

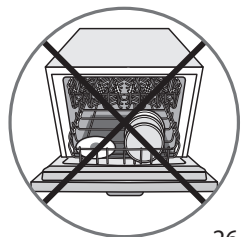

26

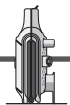

27

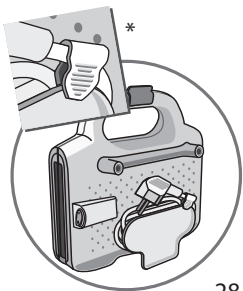

28

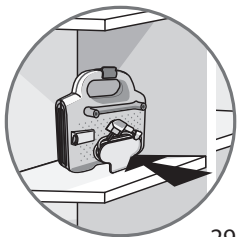

29

NC00140106